

3A, 400V - 600V Super Fast Rectifiers

FEATURES

- High efficiency, Low VF
- High current capability
- High surge current capability
- Low power loss
- Compliant to RoHS Directive 2011/65/EU and in accordance to WEEE 2002/96/EC
- Halogen-free according to IEC 61249-2-21



MECHANICAL DATA

Case: DO-204AC (DO-15)

Molding compound, UL flammability classification rating 94V-0

Packing code with suffix "G" means green compound (halogen-free)

Terminal: Pure tin plated leads, solderable per JESD22-B102

Meet JESD 201 class 1A whisker test

Weight: 1.2g (approximately)

DO-201AD

MAXIMUM RATINGS AND ELECTRICAL CHARACTERISTICS (T _A =25°C unless otherwise noted)				
PARAMETER	SYMBOL	31DF4	31DF6	UNIT
Maximum repetitive peak reverse voltage	V _{RRM}	400	600	V
Maximum RMS voltage	V _{RMS}	280	420	V
Maximum DC blocking voltage	V _{DC}	400	600	V
Maximum average forward rectified current	I _{F(AV)}	3		A
Peak forward surge current, 8.3 ms single half sine-wave superimposed on rated load	I _{FSM}	45		A
Maximum instantaneous forward voltage (Note 1) @ 3 A	V _F	1.7		V
Maximum reverse current @ rated V _R	I _R	20 100		μA
		T _J =25°C T _J =125°C		
Maximum reverse recovery time (Note 2)	t _{rr}	35		ns
Typical thermal resistance	R _{θJA}	80		°C/W
Operating junction temperature range	T _J	- 40 to +150		°C
Storage temperature range	T _{STG}	- 40 to +150		°C

Note 1: Pulse test with PW=300 μs, 1% duty cycle

Note 2: Reverse Recovery Test Conditions: I_F=0.5A, I_R=1.0A, I_{RR}=0.25A

ORDERING INFORMATION				
PART NO.	PACKING CODE	PACKING CODE SUFFIX (*)	PACKAGE	PACKING
31DFx (Note 1)	A0	G	DO-201AD	500 / Ammo box
	R0		DO-201AD	1,250 / 13" Paper reel
	B0		DO-201AD	500 / Bulk packing

Note 1: "x" defines voltage from 400V (31DF4) to 600V (31DF6)

*: Optional available

EXAMPLE				
PREFERRED P/N	PART NO.	PACKING CODE	PACKING CODE SUFFIX	DESCRIPTION
31DF4 A0G	31DF4	A0	G	Green compound

RATINGS AND CHARACTERISTICS CURVES

(T_A=25°C unless otherwise noted)

FIG.1 MAXIMUM FORWARD CURRENT DERATING CURVE

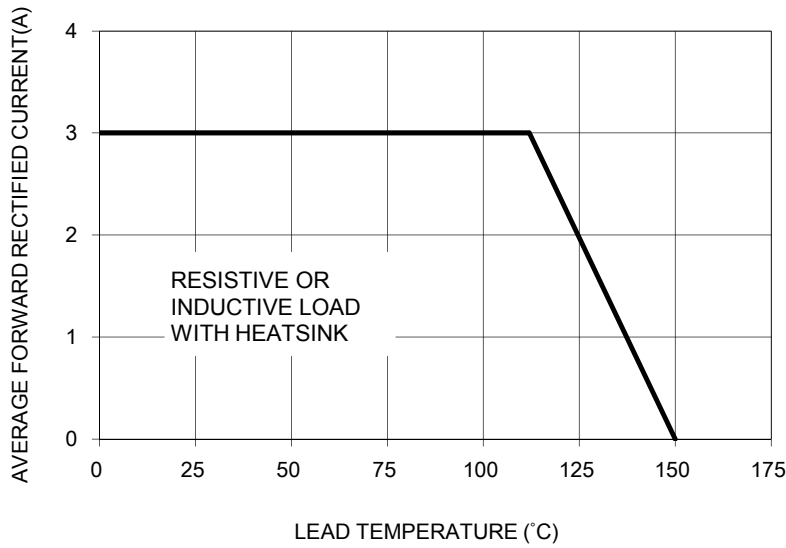

FIG. 2 TYPICAL FORWARD CHARACTERISTICS

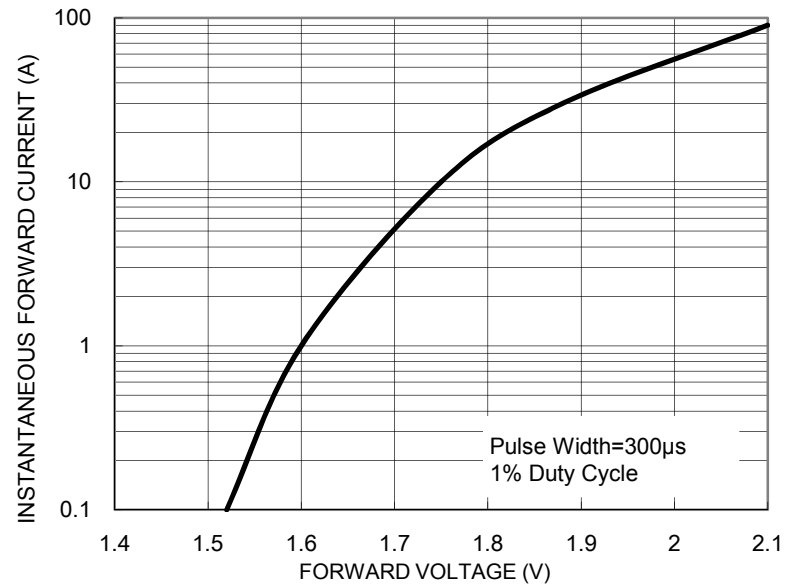

FIG. 3 MAXIMUM NON-REPETITIVE FORWARD SURGE CURRENT

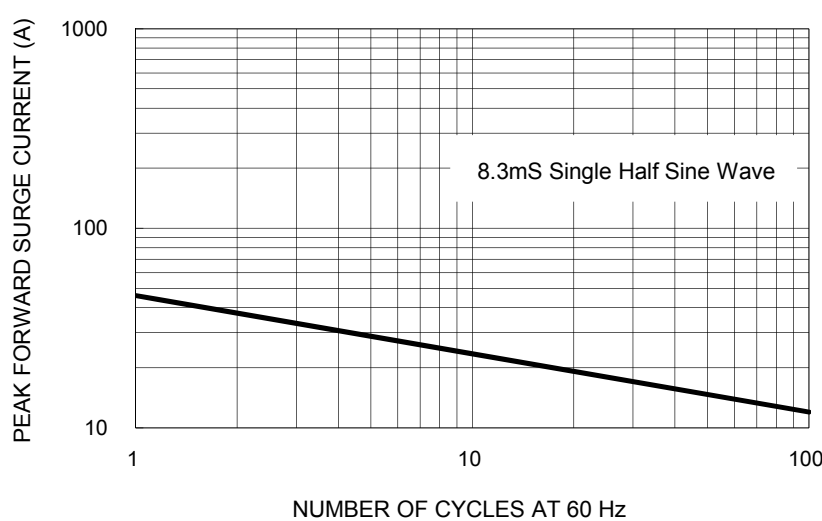

FIG. 4 TYPICAL REVERSE CHARACTERISTICS

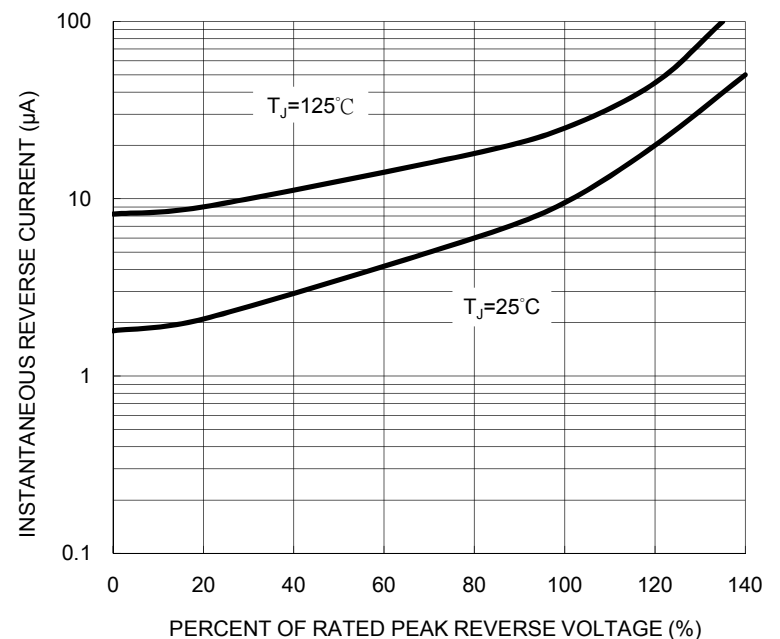

FIG. 5 TYPICAL JUNCTION CAPACITANCE

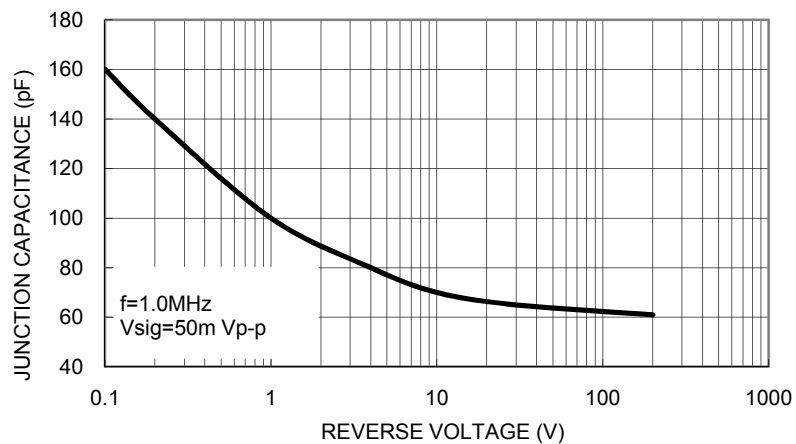
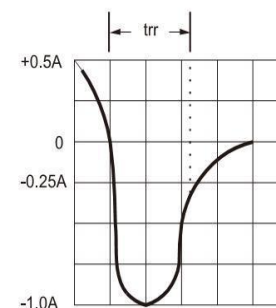
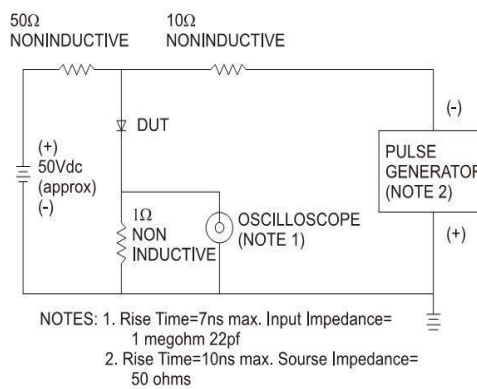
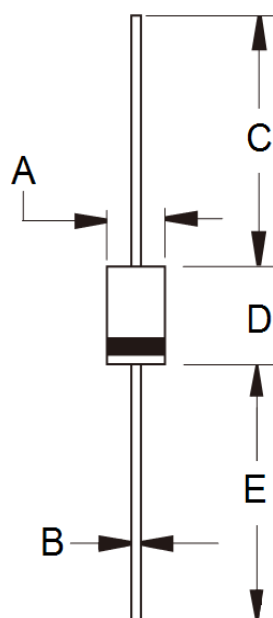

FIG.6 REVERSE RECOVERY TIME CHARACTERISTIC AND TEST CIRCUIT DIAGRAM



PACKAGE OUTLINE DIMENSIONS

DO-201AD



DIM.	Unit (mm)		Unit (inch)	
	Min	Max	Min	Max
A	5.00	5.60	0.197	0.220
B	1.20	1.30	0.048	0.052
C	25.40	-	1.000	-
D	8.50	9.50	0.335	0.375
E	25.40	-	1.000	-

MARKING DIAGRAM

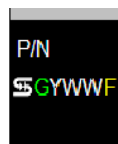

P/N = Specific Device Code
G = Green Compound
YWW = Date Code
F = Factory Code

Notice

Specifications of the products displayed herein are subject to change without notice. TSC or anyone on its behalf, assumes no responsibility or liability for any errors or inaccuracies.

Information contained herein is intended to provide a product description only. No license, express or implied, to any intellectual property rights is granted by this document. Except as provided in TSC's terms and conditions of sale for such products, TSC assumes no liability whatsoever, and disclaims any express or implied warranty, relating to sale and/or use of TSC products including liability or warranties relating to fitness for a particular purpose, merchantability, or infringement of any patent, copyright, or other intellectual property right.

The products shown herein are not designed for use in medical, life-saving, or life-sustaining applications. Customers using or selling these products for use in such applications do so at their own risk and agree to fully indemnify TSC for any damages resulting from such improper use or sale.