



## Dobot Magician - Advanced Educational Plan

SKU 110090101



### DESCRIPTION

Dobot Magician

**SHAKE HANDS WITH FUTURE**

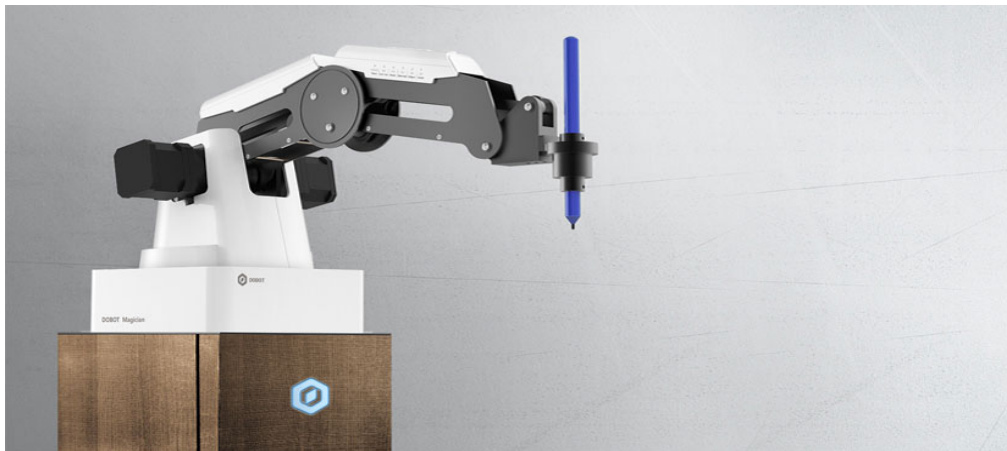

# Wisdom in shapes & colors

Black & white body with consistent quality at fingertips

Unibody design, unbox and enjoy right away

Designed for desktop, safe and easily lifted

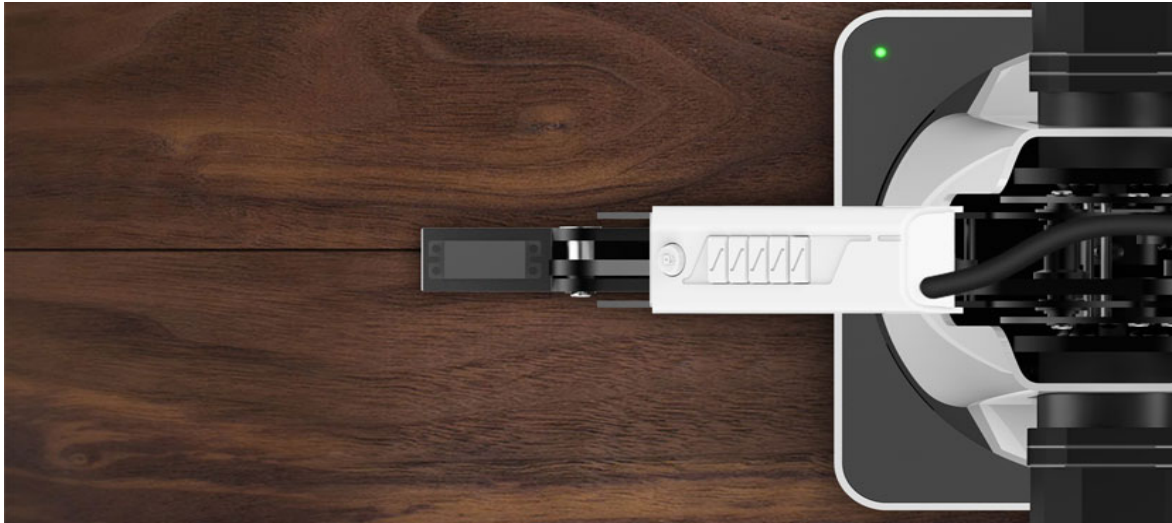

# Most user-friendly robotic arm

Thoughtful details integrated in simple design



# Controlling methods

Multiple controlling method, enjoy anytime

PC, phone, gesture, voice, even brainwave can be used to control Dobot Magician.

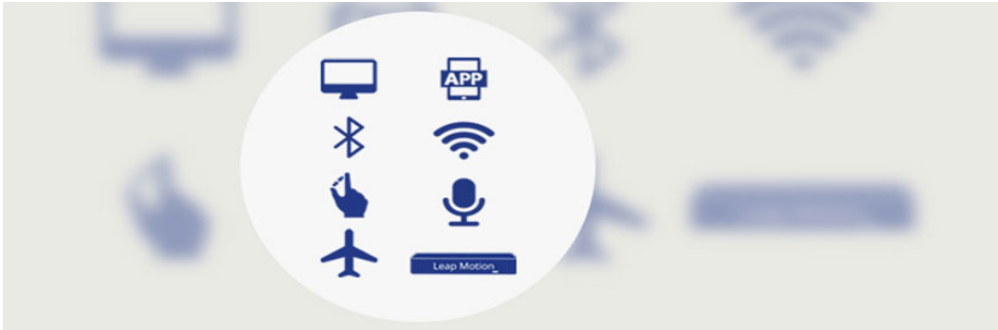

## Handhold teaching

### Handhold teaching, repeat your tasks with just a click

The handhold teaching feature lets you control a robotic arm without any limits. The most intuitive interaction bringing the best of your efficiency.



## End tool quick switch

### End tool quick switch, it's never been so smooth

With the standardized plug-in style end tool holder, you can switch end tools by simply screwing.



## Operation software

### Dobot Studio, one big step of interaction

Integrated so many features, while making it easier to control a robotic arm.

A whole set of parameters for your customization. Calibrate your own robotic arm without any coding!



## Draw like magic

Dobot Magician supports BMP, SVG and DXF

±0.2mm precision, laying perfect strokes

Powerful laser engraving, handling wood and leather with ease

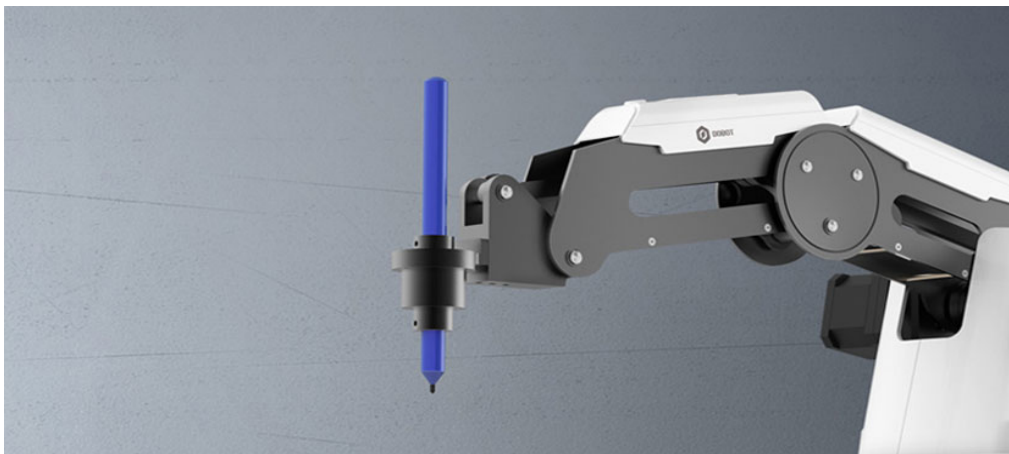

## Develop, and be ahead

Endless potential, fast deployment. Be ahead of the game.

### Rich extension ports

13 extension ports, 1 programmable key, 2MB offline command storage, endless possibilities for developers

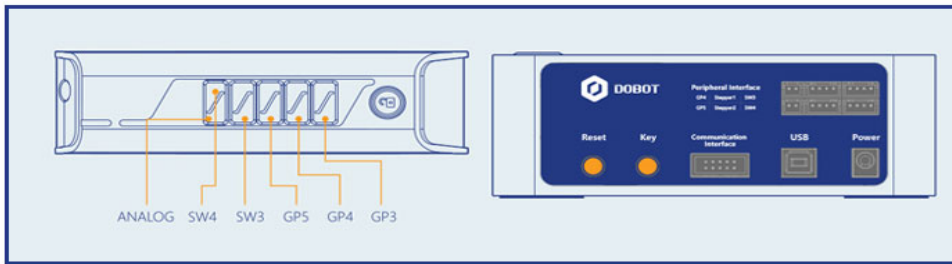

## Visualized programming

Visualized programming interface, just pile up the blocks and there's the code, the easiest way to learn coding. Support major programming languages including C++, C#, Python and java, with API and pre-set modules integrated.

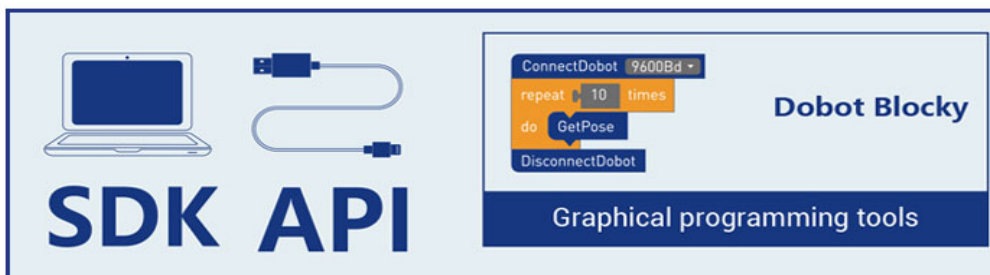

## Fast deployment

Easy to use, fast to deploy, affordable maintenance...  
A highly cost effective solution for small businesses

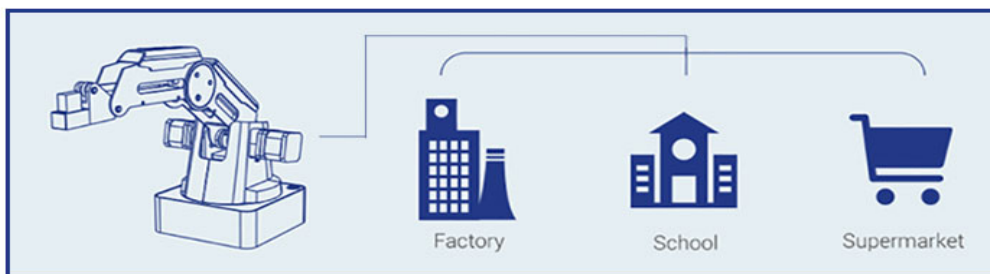

## Not only that

The Dobot Magician has every feature to blow you away

3D printing

WIFI connection

Multi-Dobot cooperation

Offline mode

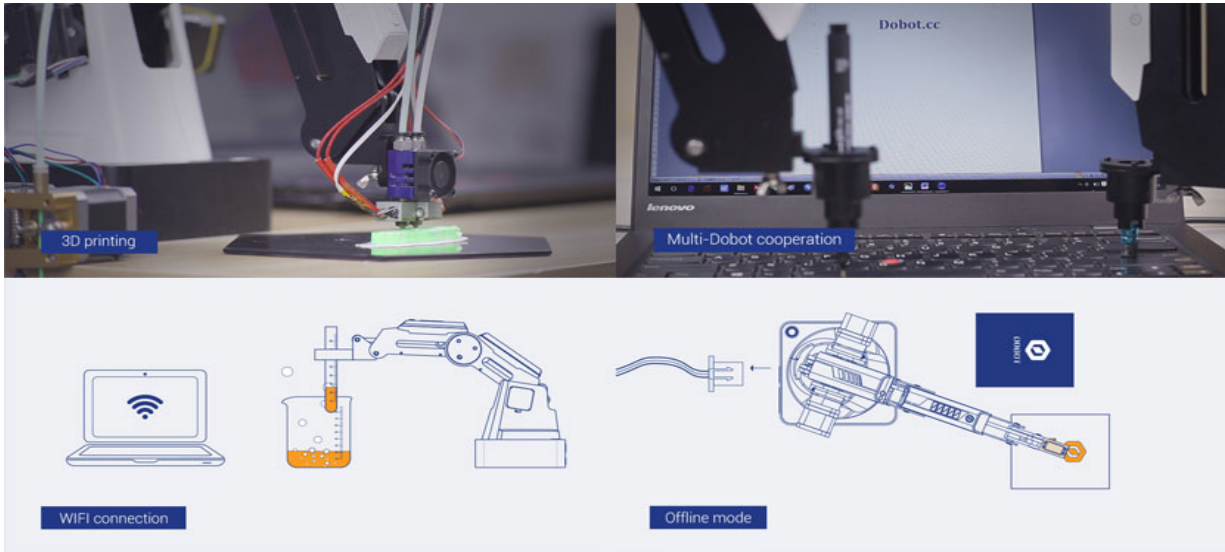

# Future lifestyle

One robot, many extensions, a highly cost effective solution  
 Enhanced human-machine cooperation, bringing efficiency to daily life  
 Technology influencing education in most entertaining ways  
 Living rooms, classrooms, workshops, factories...the future life is right ahead  
 the future life right ahead

	<p><b>Classroom</b></p> <p>Mechanics, Electronics, Programming, Design...        Knowledge empowers your life!</p>		<p><b>Home</b></p> <p>Smart, fun and reliable!</p>
<p><b>Workshop</b></p> <p>User friendly, easy to learn, bringing more efficiency.</p>		<p><b>Factory</b></p> <p>Fast to equip, easy to maintain, a high cost effective solution for production line.</p>	

# Specification

Specifications	
Number of Axes	4
Payload	500 g
Max. Reach	320mm
Position Repeatability(Control)	0.2 mm
Communication	USB /WIFI */ Bluetooth
Power Supply	100V - 240 V, 50/60 Hz
Power In	12 V / 7 A DC
Consumption	60W Max
Working Temperature	-10°C-60°C

Axis Movement		
Axis	Range	Max Speed(250g workload)
Joint 1 base	-135° to +135°	320° / s
Joint 2 rear arm	0° to +85°	320° / s
Joint 3 forearm	-10°to +95°	320° / s
Joint 4 rotation servo	+90° to -90°	480° / s

Physical	
Weight	4KG
Base Dimension(Footprint)	158mm x 158mm
Materials	Aluminum Alloy 6061, ABS Engineering Plastic
Controller	Dobot Integrated Controller
Robot Mounting	Desktop
Packing Size (L x W x H)	307mm x 224mm x 330mm

Applications	
Software	DobotStudio, Repetier Host, GrblController3.6, DobotBlockly (Visual Programing editor)
SDK (Software Develop Kit)	Communication Protocol, Dobot Program Library
Extensible I/O Interfaces	1. I/O x 10 (Configurable as Analog Input or PWM Output)
	2. Controllable 12V Power output x 4
	3. Communication Interface (UART, Reset, Stop, 12V, 5V and two I/O included)
	4. Stepper x 2

Endeffectors		
3D printer Kit	Print Size (L x W x H)	150 mm x150 mm x 150mm
	Material	PLA
	Resolution	0.1mm
Laser*	Power Consumption	500mw
	Type	405 nm (Blue laser)
	Power	12V, TTL trigger (With PWM Driver)
Pen Holder	Pen Diameter	10mm
Vacuum Suction Cap	Cap Diameter	20mm
	Pressure	-35 Kpa
Gripper	Range	27.5mm
	Drive Type	Pneumatic
	Force	8N

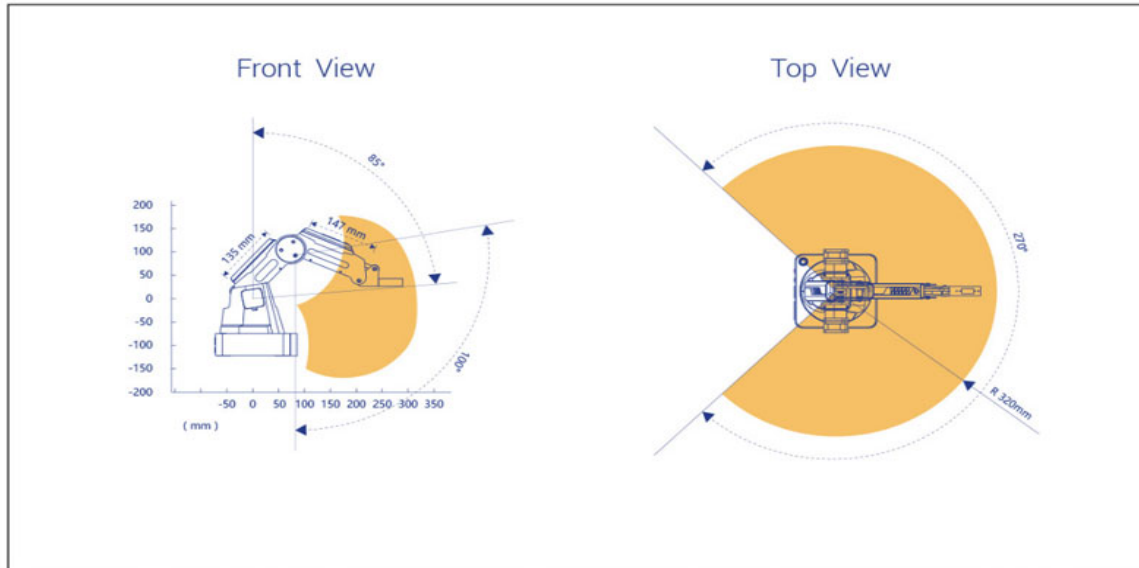

*Note: Above information is for reference only and subject to change without prior notice. Items marked with \* are optional kits, not included in default package.*

## Part List

- Robot Arm
- Gripper
- 3D Printing Kit
- **Laser Engraving Kit**
- **Joystick Control Kit**
- Vacuum pump Kit
- Writing and Drawing Kit
- Bluetooth Module
- **Wi-Fi Module**
- **Leap Motion**